

K. lactis Protein Expression Kit

NEB #E1000S

Version 4.0_12/21

Table of Contents

Method Overview	2
Strategies for Protein Expression Using pKLAC2.....	5
Cloning Strategy I: Secretion of a protein with a native N-terminus	7
Cloning Strategy II: Secretion of a protein with a non-native N-terminus	7
Cloning Strategy III: Secretion of a protein with a C-terminal hemagglutinin epitope tag	8
Cloning a PCR Fragment into pKLAC2	8
Example Protocol	9
Optional Method I: Identification of Properly Integrated Cells.....	11
Optional Method II: Identification of Multi-copy Integrants.....	12
Optional Method III: Simultaneous Expression of Multiple Proteins.....	13
Media and Solutions.....	14
References	14
Ordering Information	15
Revision History	15

The *K. Lactis* Protein Expression Kit Includes

The *K. lactis* Protein Expression Kit contains all reagents necessary to express a recombinant protein in the yeast *Kluyveromyces lactis*

Vectors

pKLAC2 Vector	20 µg
pKLAC1- <i>malE</i> Control Plasmid	20 µg

Restriction Enzyme:

SacII	2,000 units
CutSmart [®] Buffer (10X)	

Integration Identification Primers:

Integration Primer 1 (10X) – 5' d(ACACACGTAACGCGCTCGGT) 3'	500 µl
Integration Primer 2 (10X) – 5' d(ATCATCCTTGTCAGCGAAAGC) 3'	1,000 µl
Integration Primer 3 (10X) – 5' d(ACCTGAAGATAGAGCTTCTAA) 3'	500 µl

Yeast Transformation Reagents:

<i>K. lactis</i> GG799 Competent Cells	5 reactions
NEB Yeast Transformation Reagent.....	5 ml

Yeast Media:

Yeast Carbon Base (YCB) Medium Powder.....	12 grams
Acetamide Solution (100X).....	10 ml

Method Overview

The *K. lactis* Protein Expression Kit provides a method for cloning and expressing a gene of interest in the yeast *Kluyveromyces lactis* (Figures 1 and 2). Proteins may be expressed intracellularly or be secreted from the cell using the supplied expression vector pKLAC2 (Figure 3).

Secretion of proteins is the most common approach to *K. lactis* protein expression (1-3). To achieve protein secretion, the gene of interest is cloned into pKLAC2 downstream of the *K. lactis* α -mating factor domain (α -MF; Figure 4), resulting in expression of an α -MF fusion protein. The α -MF domain directs the fusion protein to be efficiently transported through the yeast secretory pathway. An α -MF fusion protein undergoes sequential processing by signal peptidase in the endoplasmic reticulum (ER) and the Kex protease in the Golgi, resulting in the secretion of a native form of the protein of interest into the growth medium (Figure 1).

Expression in yeast is driven by a mutant form of the strong *K. lactis* *LAC4* promoter ($P_{LAC4-PBi}$) that has been engineered to lack background *E. coli* transcriptional activity (1). Therefore, genes encoding products toxic to *E. coli* can be cloned into pKLAC2 in *E. coli* prior to their introduction into yeast cells. To achieve expression in yeast, pKLAC2 containing a cloned gene of interest is linearized by either SacII or BstXI to produce an expression cassette that can integrate into the *K. lactis* genome at the *LAC4* locus by homologous recombination. A fungal acetamidase gene (*amdS*) in pKLAC2 provides for selection of yeast containing an integrated expression cassette by allowing their growth on nitrogen-free minimal medium containing acetamide. Only cells expressing *amdS* can break down acetamide to ammonia for use as a nitrogen source. An advantage of this selection method is that it enriches transformant populations for cells that have integrated multiple tandem copies of the expression cassette and therefore produce more recombinant protein. Finally, the supplied *K. lactis* GG799 strain [complete genome sequence now available (4)] is an industrial isolate that has no auxotrophies, rapidly grows to high cell density, and efficiently secretes heterologous proteins.

Secretion of both eukaryotic (1-3,5,6) and prokaryotic proteins (7,8) from *K. lactis* has been achieved. Typically, proteins that are normally secreted from cells (e.g., cytokines, serum albumins, antibody fragments and glycosidases) are produced in the highest yields. In these cases, 10–50 mg of recombinant protein per liter can often be achieved in shake flasks, and yields can be further enhanced by high density cell fermentation. Secretion of other types of proteins is also possible (2,3). Secreted recombinant proteins are routinely detected in the growth medium of saturated cultures via SDS-PAGE and protein staining, Western analysis or enzyme assay. Secreted proteins may also bear post-translational modifications (e.g., asparagine-linked glycosylation) that can be removed by treatment with Endo H (NEB #P0702) or PNGase F (NEB #P0709).

Advantages

- High level and scalable expression of recombinant proteins
- Rapid high cell density growth
- Simultaneous expression of multiple proteins possible
- No background gene expression during *E. coli* cloning steps
- Easy and fast cell transformation procedure
- Antibiotic-free selection

Figure 1. Secreted protein processing.

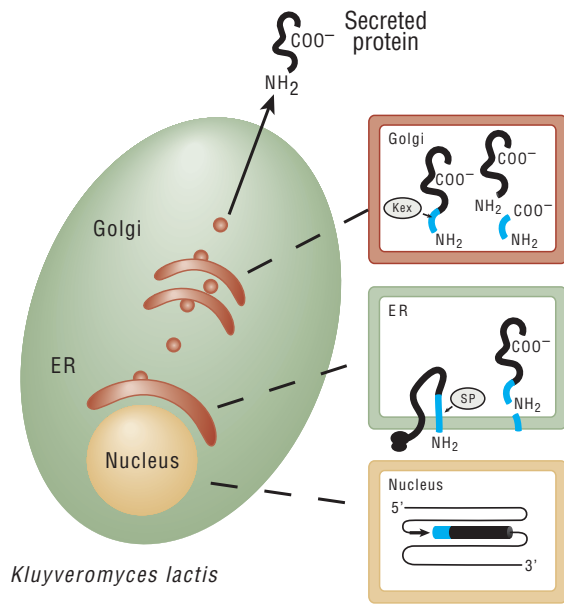

In the nucleus, DNA encoding a protein fusion of the α -MF domain (blue) and a desired recombinant protein (black) is integrated into the yeast genome. Expression is driven by the $P_{LAC4-PBI}$ promoter (arrow). Upon expression of the fusion protein, a signal peptide in the α -MF domain directs translocation of the fusion protein into the lumen of the endoplasmic reticulum (ER) and is removed by signal peptidase (SP). Secretory vesicles (circles) transport the fusion protein to the Golgi where the Kex endoprotease cleaves the α -MF pro-domain, releasing a mature form of the desired protein. The protein of interest is then transported via vesicles to the plasma membrane (PM) where it is secreted from the cell.

Figure 2. Method Overview of the *K. lactis* Protein Expression Kit.

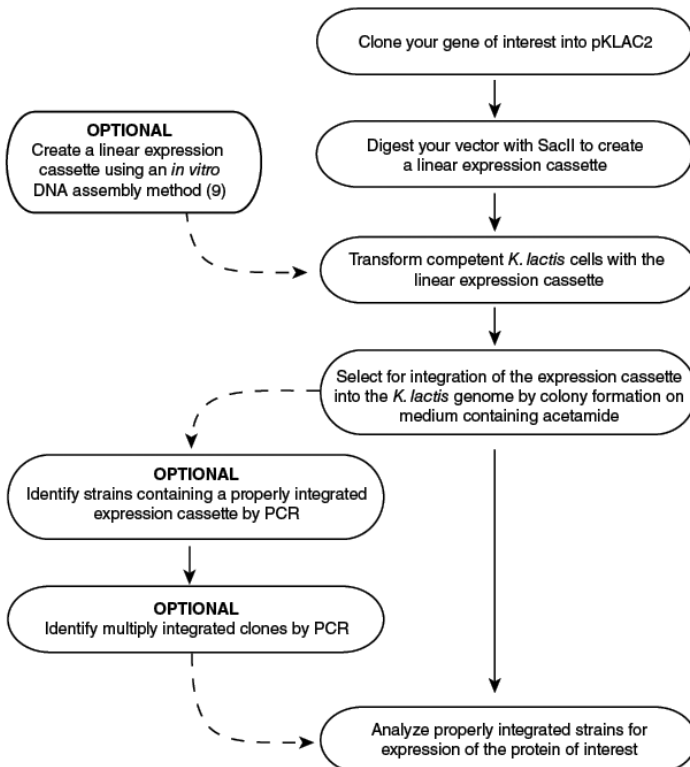
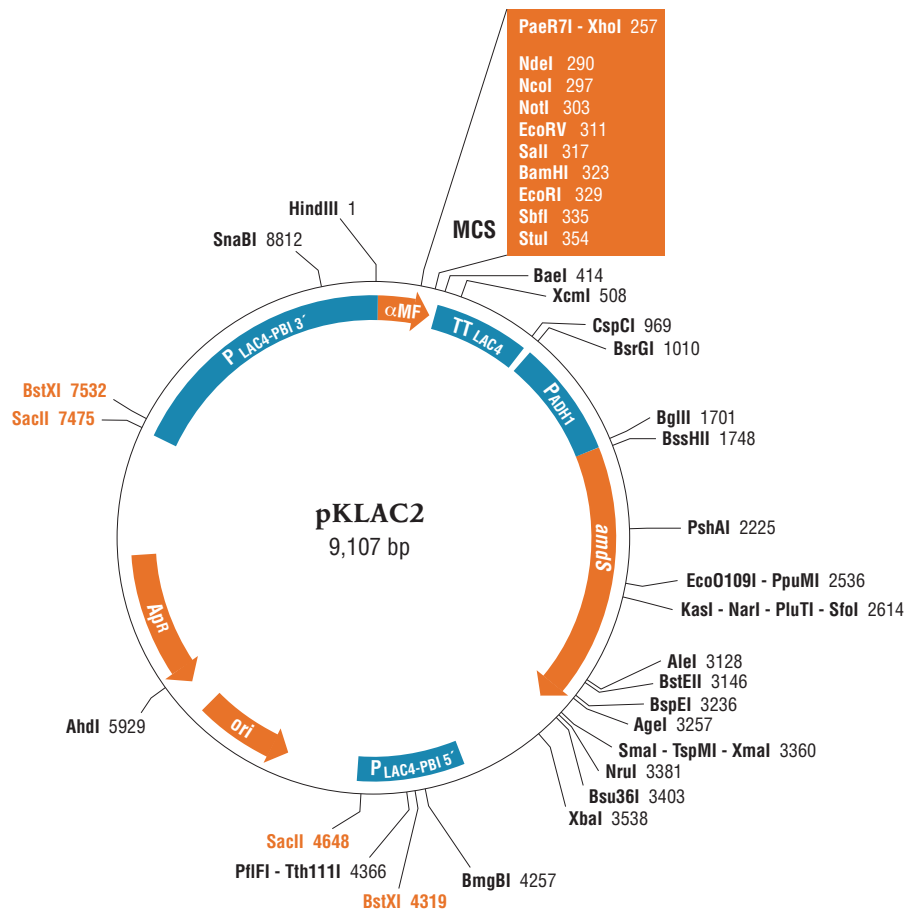
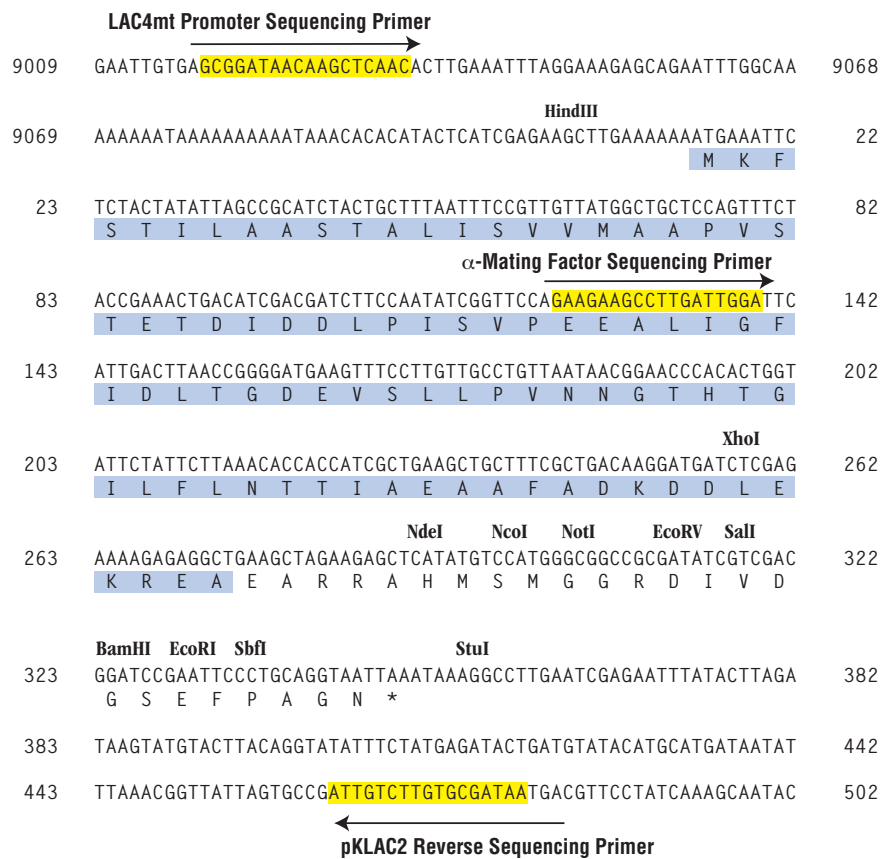

Figure 3. The pKLAC2 expression vector.



pKLAC2 (9107 bp) contains the 5' and 3' ends of the *LAC4* promoter ($P_{LAC4-PBI}$) separated by DNA encoding β -lactamase (Ap^R) and the *pMB1* origin (*ori*) to allow for its propagation in *E. coli*. The *K. lactis* α -mating factor secretion leader sequence (α -MF), multiple cloning site (MCS), and the *LAC4* transcription terminator (TT) lie immediately downstream of 3' $P_{LAC4-PBI}$. The yeast *ADHI* promoter (P_{ADHI}) drives expression of an acetamidase selectable marker gene (*amdS*). The vector can be linearized by digestion with *SacII* or *BstXI* to create a linear DNA fragment capable of inserting into the native *LAC4* promoter region of the *K. lactis* genome.

Figure 4. pKLAC2 multiple cloning site.



pKLAC2 (9107 bp) contains the *K. lactis* α -mating factor secretion leader sequence (blue background) and a polylinker immediately downstream of the *P_{LAC4-PBI}* promoter. Unique polylinker restriction sites are indicated. Arrows indicate the positions of *pKLAC*-series vector-specific sequencing primers that you can have synthesized to confirm your target gene is properly cloned.

Strategies for Protein Expression Using pKLAC2

pKLAC2 can be used for either intracellular or secreted expression of proteins of interest in *K. lactis*. The following sections describe various factors that influence how genes should be cloned into *pKLAC2* to achieve the desired method of expression.

Secreted protein expression using pKLAC2

Secretion of a protein of interest from *K. lactis* cells is the most common approach to protein expression. Secretion results in production of proteins that are significantly pure, that do not require difficult lysis of yeast cells to isolate, and that may have desired post-translational modifications (e.g., glycosylation) that cytosolic proteins do not. Protein secretion using *pKLAC2* is achieved by generating a fusion between the protein of interest and the α -MF secretion domain present in the vector. To do this, a gene or open reading frame of interest must be inserted into *pKLAC2* so that it is in the same translational reading frame as the α -MF domain. It is also required to have a Kex protease processing site (KR↓) at the junction between the α -MF domain and the N-terminus of the protein of interest.

Because fusion proteins will be processed by the Kex protease in the Golgi, there are two strategies for making fusions to the α -MF domain. The first strategy generates a secreted recombinant protein with a native N-terminus, and the second produces a protein with additional vector-encoded amino acids at its N-terminus. The first strategy makes use of the unique XhoI site that lies immediately upstream of DNA encoding the Kex protease cleavage site. A gene cloned into XhoI must contain DNA at its 5' end that reconstitutes the Kex protease cleavage site to allow for processing of the pro-protein (see Cloning Strategy I). In cases where the gene of interest contains an XhoI site or a native N-terminus is not required on the protein of interest, in-frame fusion with the α -MF domain may be achieved by cloning a gene into any of the other restriction sites that reside in the polylinker (see Cloning Strategy II). Fusion proteins made this way will contain additional amino acids encoded by vector DNA that reside between the Kex site and the polylinker restriction sites.

Native signal sequences

Naturally secreted proteins contain native secretion leader sequences. While various signal sequences can direct secretion of certain proteins from *K. lactis* (2-3), it is recommended to replace the protein's native leader sequence with the *K. lactis* α -MF domain sequence present in *pKLAC2*. Predictive algorithms such as SIGNAL P (<http://www.cbs.dtu.dk/services/SignalP/>) can be used to determine if a protein contains a native secretion leader sequence.

Intracellular protein expression using pKLAC2

Because yeast cells are difficult to lyse, secretion is the most common approach to expression in *K. lactis*. However, it is possible to use pKLAC2 to express a protein intracellularly (8). In this case, it is not necessary to create a fusion to the α -MF domain. A gene of interest should be cloned into pKLAC2 using the unique HindIII site immediately upstream of the α -MF domain and any of the polylinker sites. This places the gene of interest immediately downstream of the strong P_{LAC4-PBI} promoter. In this case, it is important to ensure that the desired gene begins with a methionine codon to initiate translation. If the desired gene does not begin with a methionine codon, one should be added by PCR or site-directed mutagenesis.

It is important to note that when expressing a gene in this manner, identification of properly integrated strains or multiply integrated strains by PCR (see Optional Methods on pages 11 and 12) is not possible using Integration Primer 2. Integration Primer 2 anneals to a region of pKLAC2 DNA that lies between the HindIII site and the polylinker, and is removed during cloning for intracellular expression. Instead, a custom reverse primer can be designed that anneals to the 5' end of the gene of interest (for more details, please visit the *K. lactis* Protein Expression Kit FAQs at www.neb.com) and can be used in place of Integration Primer 2 in the Optional Methods. Additionally, the α -Mating Factor Sequencing Primer (Figure 4) cannot be used to sequence the 5' end of genes cloned in this manner. The LAC4mt Promoter Sequencing Primer (Figure 4) should be used instead. Please note that these primers should be synthesized as they are not supplied with the kit, nor available from New England Biolabs.

Epitope tagging

To allow for detection of secreted recombinant protein in the culture medium by western blotting, it may be desirable to create a fusion to a peptide epitope tag. Cloning Strategy III illustrates the use of PCR to incorporate DNA encoding a C-terminal hemagglutinin (HA) peptide epitope and a stop codon into the gene of interest. While this method could be used to add any antibody epitope tag to the C-terminus of the target protein, the HA antibody epitope tag has performed exceptionally well for detection and small scale purification of heterologous proteins secreted from *K. lactis* due to its lack of cross-reactivity with native host proteins during western blotting applications.

Tagging secreted proteins with C-terminal polyhistidine sequences is not recommended. In the majority of reported cases, proteins with a tag of six histidine residues will not bind efficiently to nickel columns and are difficult to detect by western analysis using anti-HIS tag antibodies. If C-terminal His-tagging is absolutely necessary, it is recommended to add a stretch of at least 10 histidine residues to the C-terminus of the target protein to offset potential amino acid loss by the action of host carboxypeptidases.

Incorporation of stop codons

It is assumed that the gene of interest will include a stop codon (TAG, TAA or TGA) at its 3' end. If it does not, one should be engineered into the cloning strategy. Stop codons may be incorporated into reverse PCR primers as shown in Cloning Strategies I, II and III.

Cloned Genes must be free of SacII or BstXI restriction sites

Vector pKLAC2 containing the gene of interest must be linearized with either SacII or BstXI to create an expression cassette that can be stably integrated into the *K. lactis* genome at the *LAC4* locus upon its introduction into *K. lactis*. Therefore, the gene of interest must be free of either SacII or BstXI sites. If the gene contains both restriction sites, then either all SacII sites or all BstXI sites must be removed using site-direct mutagenesis prior to transforming *K. lactis* cells.

Alternatively, the use of *in vitro* DNA assembly methods to construct linear expression cassettes suitable for direct introduction into yeast circumvents this limitation (9). More information can be found in the application note *Improved Method for Assembly of Linear Yeast Expression Cassettes* using NEBuilder HiFi DNA Assembly Master Mix available at www.neb.com.

Sequencing

Genes cloned into vector pKLAC2 should be sequenced prior to transformation of *K. lactis*. The positions of pKLAC2-specific sequencing primers are shown in Figure 4. These primers are not supplied with the kit, nor available from New England Biolabs; one should have these synthesized in order to sequence verify the cloned gene of interest. The sequence of vector pKLAC2 is available at www.neb.com.

Cloning Strategy I

Secretion of a protein with native N-terminus

Shown are PCR primers (blue background) designed for amplification of an example gene of interest (yellow background) for cloning into pKLAC2. The Forward Primer must contain an XhoI site and a Kex protease cleavage site (boxed) immediately followed by the first codon of the gene's open reading frame. The Reverse Primer must include a restriction site for cloning into any of the polylinker sites of pKLAC2 (NotI shown).

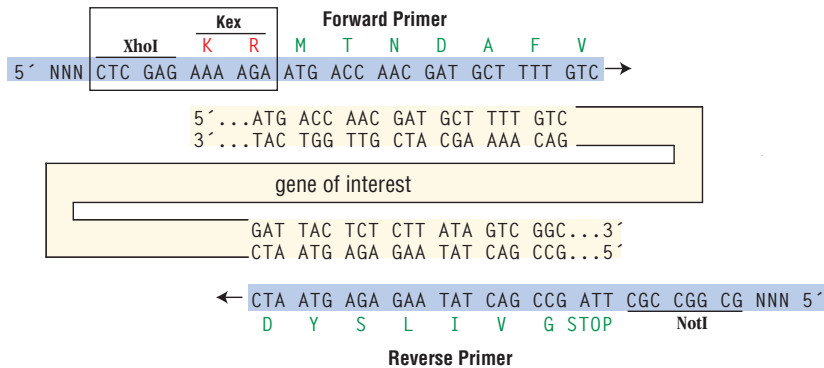

After Kex processing, the protein of interest (green) containing a native N-terminus is secreted.

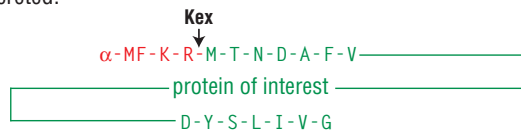

Cloning Strategy II

Secretion of a protein with non-native N-terminus

In cases where the gene of interest contains an XhoI site, one may clone the gene in-frame with the α-MF domain using other sites in the pKLAC2 polylinker. This strategy results in vector-encoded amino acids being added to the protein's N-terminus. Shown are PCR primers (blue background) designed for amplification of an example gene of interest (yellow background) for cloning into the NotI and BamHI polylinker sites of pKLAC2.

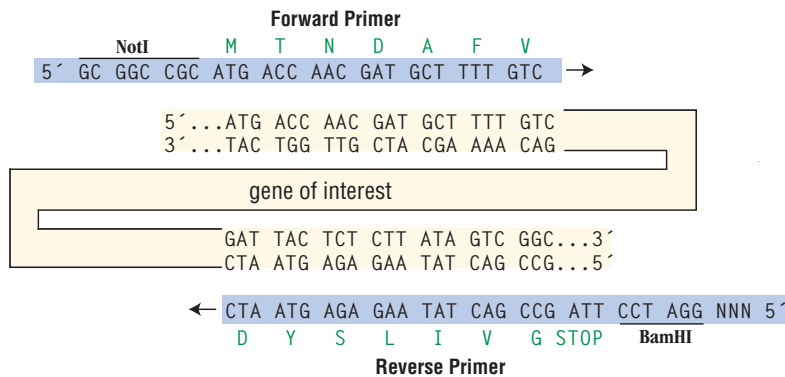

After Kex processing, the secreted form of the protein of interest (green) contains extra vector-encoded amino acids at its N-terminus (dashed underline).

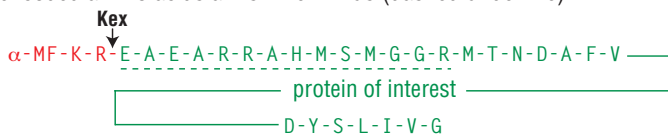

Cloning Strategy III

Secretion of a protein with a C-terminal hemagglutinin epitope tag

Shown are PCR primers (blue background) designed for amplification of an example gene of interest (yellow background) having a C-terminal antibody epitope tag (hemagglutinin epitope [HA] shown). The Forward Primer should be designed as shown in Cloning Strategies I or II (Strategy I shown). The Reverse Primer should contain DNA encoding an HA epitope tag, a stop codon, and a restriction site for cloning into the polylinker of pKLAC2 (NotI shown).

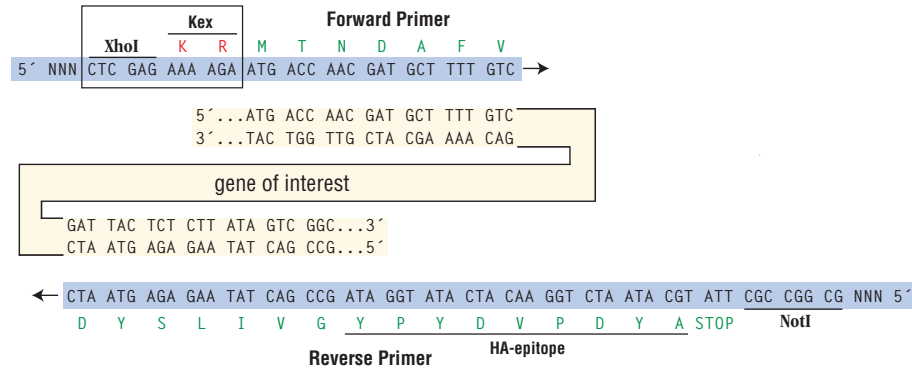

After Kex processing, the protein of interest (green) containing a C-terminal HA-epitope (underlined) is secreted.

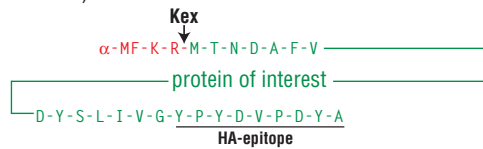

Cloning a PCR Fragment into pKLAC2

The procedure below is for cloning a fragment produced by PCR into pKLAC2. This example assumes that the PCR fragment contains a 5' XhoI site, and has a stop codon followed by a NotI site incorporated into its 3' end (see Cloning Strategy I).

1. Prepare a PCR fragment of the gene of interest as outlined in Cloning Strategy I on page 7.
2. Digest 0.5 μ g of pKLAC2 DNA with 10 units of XhoI (NEB #R0146) and 10 units of NotI (NEB #R0189) in 20 μ l of 1X NEBuffer 3.1 (supplied as a 10X stock) at 37°C for 2 hours.
3. Digest 0.5 μ g of the PCR fragment with 10 units of XhoI and 10 units of NotI in 20 μ l of 1X NEBuffer 3.1 at 37°C for 2 hours.
4. Add an equal volume of phenol:chloroform (1:1, v/v) to the restriction digests, mix and remove the aqueous (top) phase to a fresh tube. Repeat using only chloroform.
Alternatively, the DNA fragments can be isolated using one of the many commercially available fragment purification kits [e.g., Monarch[®] PCR & DNA Cleanup Kit (NEB #T1030)]. If a kit is used, skip to Step 8.
5. Add 10 μ g glycogen or tRNA as carrier to both digests, then add a 1/10th volume 3M sodium acetate, mix and add an equal volume of 100% isopropanol. Incubate at room temperature for 10 minutes.
6. Microcentrifuge at 12,000 x g for 15 minutes. Pour off the supernatant and gently rinse the pellet with 70% ethanol. Allow the pellet to air-dry (~10 minutes).
7. Resuspend each sample in 25 μ l of 10 mM Tris-HCl, 1 mM EDTA (pH 8.0).
8. Mix: 2 μ l pKLAC2 digest (~40 ng)
1 μ l PCR fragment (insert digest) (~20 ng)
2 μ l 10X T4 DNA Ligase Buffer
14 μ l deionized water
1 μ l (~400 units) T4 DNA Ligase (NEB #M0202)
9. Incubate at 16°C for 2 hours to overnight.
Completed ligation reactions can be stored frozen at -20°C indefinitely prior to transformation.
10. Transformation of frozen competent NEB 5-alpha F' I⁹ Competent *E. coli* (NEB #C2992) is recommended using 2–4 μ l of the ligation reaction.
Any competent E. coli strain can be used. However, blue-white screening is not possible with pKLAC2.
11. Prepare miniprep DNA from several transformants. Digest each vector with an appropriate restriction endonuclease to determine the presence of a cloned insert.
Expression vectors may be stored frozen at -20°C indefinitely.

Example Protocol

An example experiment is described to illustrate creation of a *K. lactis* strain that is capable of secreting a protein of interest. This is accomplished by linearizing pKLAC2 containing a cloned gene of interest, inserting the linearized expression vector into the *K. lactis* genome by integrative transformation, and growing cells to achieve secretion of the desired protein into the growth medium. A control pKLAC2 vector containing the *E. coli* malE gene (pKLAC1-malE) that encodes the maltose binding protein (MBP) is supplied with the kit and can be processed in parallel using this protocol. Integration of pKLAC1-malE into the *K. lactis* genome routinely yields cells that secrete > 25 mg MBP per liter of culture.

Linearization of pKLAC2 for integrative transformation of *K. lactis*

pKLAC2 containing any desired gene must be linearized to allow it to insert into the *K. lactis* genome at the *LAC4* locus (Figure 5). This is accomplished by digesting the construct with either SacII (supplied with kit) or BstXI (NEB #R0113) to generate an “expression cassette” consisting of > 6.2 kb of DNA containing P_{LAC4-PBI}, the cloned gene and the amdS selection cassette, and a 2.8 kb fragment containing the remaining pKLAC2 vector DNA. The cloned gene must be free of SacII sites (or BstXI sites if digesting with BstXI) to allow for generation of the proper expression fragment. It is not necessary to purify the expression fragment from the remaining vector DNA following digestion as only the expression fragment will integrate into the *K. lactis* genome upon transformation.

1. Digest 2 µg of pKLAC2 DNA containing the gene of interest with 20 units of SacII in 50 µl of 1X CutSmart[®] Buffer (supplied as a 10X stock) at 37°C for 2 hours.

The pKLAC1-malE control vector can be linearized only with SacII due to the presence of a BstXI site in the malE gene.

2. Desalt digested DNA using a commercially available DNA fragment purification kit [e.g., Monarch PCR & DNA Cleanup Kit (NEB #T1030)].

A total of 1 µg of linearized DNA in a volume less than 15 µl will be needed to transform K. lactis cells. DNA may be stored frozen at -20°C for up to one month prior to transforming K. lactis cells.

Transformation of *K. lactis* GG799 cells

Introduction of the linearized expression cassette into *K. lactis* cells is achieved by chemical transformation using the *K. lactis* GG799 Competent Cells and NEB Yeast Transformation Reagent supplied with the kit. This procedure yields up to 1×10^4 transformants per microgram of DNA. Transformants are selected by growth on Yeast Carbon Base (YCB) Agar Medium containing 5 mM acetamide (see Media & Solutions). YCB medium contains glucose and all nutrients needed to sustain growth of *K. lactis* GG799 cells except a simple nitrogen source. Cells can utilize acetamide as a source of nitrogen only after it is broken down to ammonia by acetamidase, the product of the *amdS* gene present in pKLAC2.

The following steps should be conducted using aseptic technique. Care should be taken to ensure that pipet tips, tubes, solutions and deionized water are sterilized prior to use.

1. Thaw a tube of *K. lactis* GG799 Competent Cells on ice. Add 620 µl NEB Yeast Transformation Reagent directly to the tube of cells. Briefly shake or invert the tube until the solution is homogeneous. *Do not vortex.*
2. Add 1 µg of linearized pKLAC2 DNA containing the gene of interest to the cell mixture. Briefly shake or invert the tube to mix. *Do not vortex. The total volume of transforming DNA should not exceed 15 µl.*
3. Incubate the mixture at 30°C for 30 minutes.
4. Heat shock the cell mixture by incubation at 37°C for 1 hour in a water bath.
5. Pellet cells by microcentrifugation at 4,600 x g (~7000 rpm) for 2 minutes and discard the supernatant.
6. Resuspend the cell pellet in 1 ml sterile YPGlu medium (see Media & Solutions, page 14).
7. Pellet cells by microcentrifugation at 4,600 x g (~7000 rpm) for 2 minutes and discard the supernatant.
8. Resuspend the cell pellet in 1 ml YPGlu medium and transfer the cell mixture to a sterile culture tube. Incubate with shaking (250–300 rpm) at 30°C for 3–4 hours. *Incubations shorter than 3 hours are not recommended due to a decline in transformation efficiency.*
9. Transfer the cell mixture to a sterile 1.5 ml microcentrifuge tube. Pellet the cells by microcentrifugation at 4,600 x g (~7000 rpm) for 2 minutes and discard the supernatant. Resuspend the cell pellet in 1 ml sterile 1X PBS (see Media & Solutions, page 14).
10. Transfer 10, 50 and 100 µl of the cell suspension to separate sterile 1.5 ml microcentrifuge tubes each containing 50 µl of sterile deionized water. Mix briefly and spread the entire cell mixture from each tube onto separate YCB Agar Medium plates containing 5 mM acetamide (see Media & Solutions). Incubate plates inverted at 30°C for 3–4 days until colonies form. *Due to the high transformation efficiency of K. lactis GG799 Competent Cells, plating multiple dilutions of the cell mixture is necessary to ensure formation of plates with distinct single colonies. Growth time should not exceed 5 days as small background colonies that lack an integrated expression fragment may form. Plates containing colonies can be stored at 4°C for up to two weeks.*
11. Streak or patch 10–20 individual colonies onto fresh YCB Agar Medium plates containing 5 mM acetamide. Incubate at 30°C for 1–2 days.

Patches of approximately 1.0 cm² are recommended. Plates containing patched cells may be stored at 4°C for up to 3 days prior to performing whole-cell PCR (optional Steps 12, 13).

12. [OPTIONAL] Transformants can be tested to verify that they have correctly integrated the expression fragment (see Identification of Properly Integrated Cells, page 11).
13. [OPTIONAL] Correctly integrated transformants can be further screened to identify cells that have integrated multiple tandem copies of the expression fragment (see Identification of Multicopy Integrants, page 12).

Figure 5. Genomic integration of a linear expression cassette.

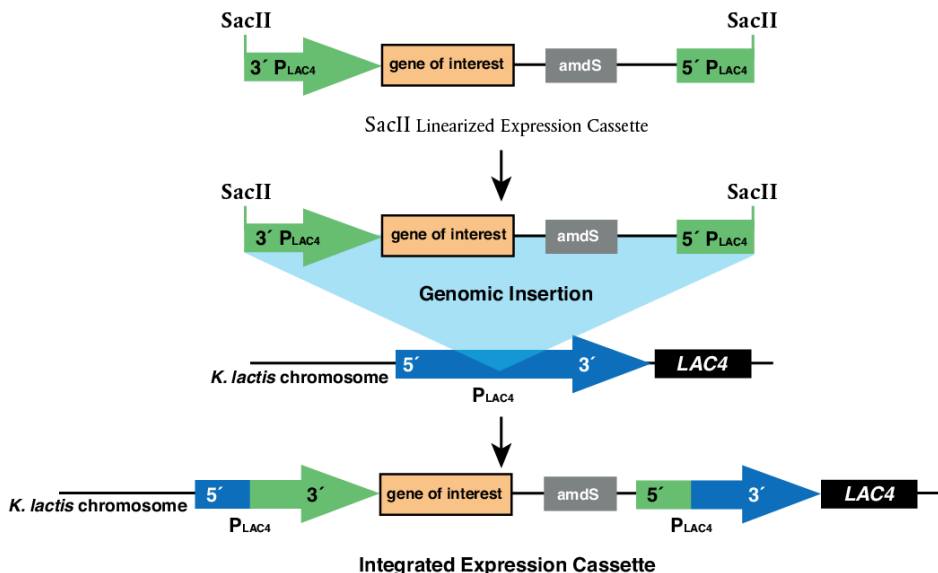

Vector pKLAC2 containing the gene of interest is digested with either *SacII* or *BstXI* (*SacII* shown) and introduced into *K. lactis* cells. The 5' P_{LAC4} and 3' P_{LAC4} sequences direct insertion of the cassette into the promoter region of the *LAC4* locus in the *K. lactis* genome.

Growth of strains for detection of secreted protein

1. From the patch of each strain that contains an integrated expression fragment, harvest cells from an area approximately 2 mm² by scraping with a sterile pipette tip and resuspending the cells in 2 ml of YPGal medium (see Media & Solutions, page 14) in a sterile culture tube. Incubate the cultures with shaking (~250 rpm) at 30°C.
The duration of growth will vary depending on the protein being secreted. As a general rule, allow a minimum of 2 days growth at 30°C to obtain a saturated culture (a culture density of > 30 OD₆₀₀ units/ml). Analysis of culture supernatant may be performed each day thereafter to determine the optimum growth time to achieve maximum secretion of the protein of interest. Culture sizes will ultimately depend on the desired application. For example, to determine the efficiency of secretion on previously untested cells, 2 ml cultures allow for simultaneous analysis of many strains. Larger cultures (e.g., ≥ 1 L) for protein purification should be inoculated 1:100 with a starter culture grown overnight at 30°C.
2. Microcentrifuge 1 ml of each culture for 30 seconds to pellet cells. Remove the culture supernatant to a fresh microcentrifuge tube and store on ice.
3. Since expression levels of recombinant proteins secreted from *K. lactis* vary from protein to protein, culture supernatant samples must be analyzed to determine if the protein of interest is being secreted. Polyacrylamide gel electrophoresis followed by Coomassie or silver staining of unconcentrated culture supernatant (15 µl per lane) allows for visual detection of proteins that are highly secreted (e.g., > 10 mg/l) (Figure 6A). Alternatively, Western blotting can detect lesser quantities of secreted protein (Figure 6B). If an antibody to your protein of interest is unavailable, an antibody epitope tag (e.g., hemagglutinin (HA) peptide epitope) can be engineered as a C-terminal fusion to the protein of interest (see Cloning a PCR Fragment, Strategy III). Finally, if the protein of interest is an enzyme, culture supernatant may be analyzed for the presence of the protein directly by activity assay (Figure 7). In such cases, it is important to note that the absence of an enzyme activity in culture supernatant does not always indicate a lack of secretion. For example, the enzyme may be secreted in an inactive form or the nutrient rich growth medium may inhibit the activity assay. In such cases, absence of secretion of the protein of interest should also be confirmed by SDS-PAGE or Western analysis.
4. *K. lactis* cells can be stored at -70°C suspended in a final concentration of 20% (v/v) sterile glycerol. For example, 500 µl of a culture of freshly grown cells can be diluted with 500 µl of a sterile 40% glycerol solution (to give a 20% final glycerol concentration). Alternatively, a scoop of cells from a freshly grown streak on agar medium can be scraped from the plate using a sterile loop or pipet tip and resuspended directly in 20% sterile glycerol. It is important to make sure that all solutions and tubes that contact the cells are sterilized prior to their use. To revive frozen *K. lactis* cells containing an integrated pKLAC2 construct, streak a small aliquot of

frozen cells on YCB agar medium supplemented with 5 mM acetamide. After this initial growth on YCB agar medium, the cells can be grown without selection in rich medium for protein expression.

Optional Method I

Identification of Properly Integrated Cells

Transformants in which the expression cassette has correctly integrated into the *K. lactis* genome can be identified by PCR using supplied Integration Primers 1 and 2 to amplify a 2.65 kb product (Figure 8A). To facilitate simultaneous screening of many transformants, PCR using freshly grown cells as a source of template chromosomal DNA is recommended.

1. For each transformant patched and grown on YCB Agar Medium plates containing 5 mM acetamide (see Example Experiment Step 11), harvest cells from an area approximately 1 mm² by scraping with a pipette tip and resuspend the cells in 100 µl of 0.2 M LiAc containing 1% (w/v) SDS (adapted from reference 10).
2. Incubate at 70°C for 15 minutes then add 300 µl 100% ethanol and vortex to mix.
3. Centrifuge the cells at 15,000 x g for 3 minutes at room temperature.
4. Carefully remove the supernatant and air dry the pellet for 10 minutes.
5. Resuspend the pellet in 50 µl TE (10 mM Tris-HCl, pH 7.5 containing 1 mM EDTA).
6. Centrifuge to remove any insoluble material for 30 seconds at 13,000 x g.
7. Transfer the supernatant to a fresh tube and keep on ice. Use 1 µl as a template for a 50 µl PCR reaction as follows:

10X Integration Primer 1 (7.8 µM stock)	3.2 µl
10X Integration Primer 2 (7.8 µM stock)	3.2 µl
Q5 [®] High-Fidelity 2X Master Mix (NEB #M0492)	25 µl
LiAc/SDS treated supernatant from Step 7 above	1.0 µl
Deionized water	17.6 µl
Final reaction volume	50 µl

8. Thermocycling should consist of an initial denaturation at 98°C for 30 seconds followed by 30 rounds (98°C for 10 seconds, 60°C for 30 seconds and 72°C for 75 seconds) and a final extension at 72°C for 2 min.
9. Analyze 10 µl of each amplification reaction on a 1% agarose gel.
Integration of the expression fragment at the LAC4 locus in the K. lactis genome will result in amplification of a 2.65 kb product (Figure 8A).
10. Test strains harboring a properly integrated expression fragment for secretion of the protein of interest (see Growth of strains for detection of secreted protein, page 10).

Figure 6. SDS-polyacrylamide gel electrophoresis of secreted recombinant maltose binding protein (MBP).

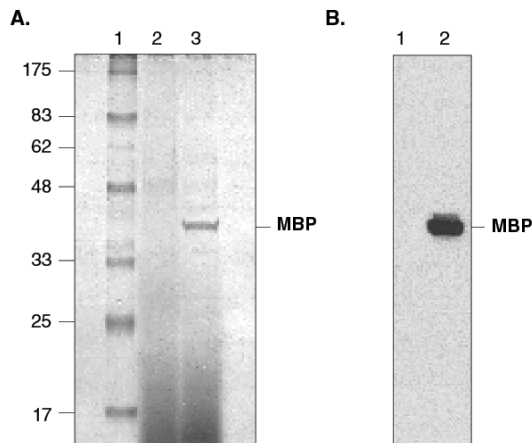

A) Detection of secreted MBP by Coomassie staining. Lane 1: Protein Molecular Weight Markers. Lane 2: spent culture medium (15 µl) from wild-type *K. lactis* cells. Lane 3: spent culture medium (15 µl) from *K. lactis* cells harboring an integrated expression cassette containing the *E. coli malE* gene. (B) Detection of secreted MBP by Western analysis using a polyclonal anti-MBP antibody (NEB #E8032; 1:2000 dilution) and an anti-rabbit IgG-HRP secondary antibody (1:2000 dilution). Lane 1: culture medium from *K. lactis* cells (15 µl). Lane 2: culture medium (15 µl) from *K. lactis* cells containing the *E. coli malE* gene.

Figure 7. Activity of secreted bovine enterokinase.

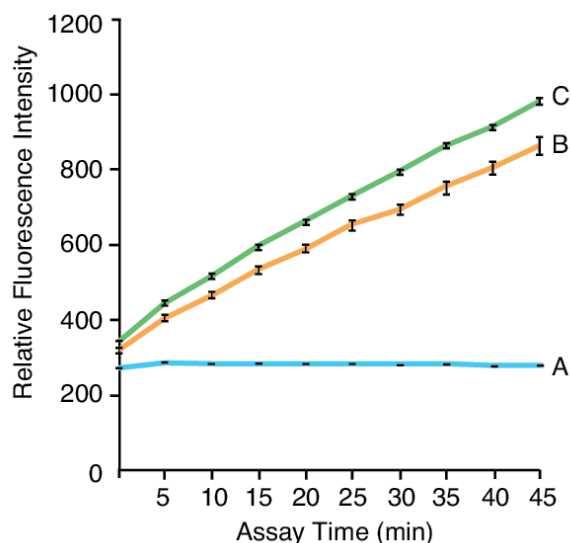

Enterokinase proteolytic activity measured in the spent culture medium of wild-type *K. lactis* cells as a control (A). *K. lactis* cells harboring a single integrated expression cassette containing a bovine enterokinase cDNA (B) and *K. lactis* cells harboring multiple integrations of the expression cassette (C). Activity was assayed by measuring an increase in fluorescence over time produced in reactions containing 25 μ l spent culture medium and a fluorogenic peptide.

Optional Method II

Identification of Multi-copy Integrants

It is possible for up to 10 copies of the expression cassette to tandemly insert into the genome during transformation. Strains harboring multiple integrations often produce more secreted protein. An advantage of selection for *K. lactis* transformants on YCB Agar Medium containing acetamide is that it enriches for cells harboring multiple tandem integrations (Figure 8B). Multiply integrated cells can be identified using whole-cell PCR with Integration Primers 2 and 3 to amplify a 2.58 kb product.

- For each transformant patched and grown on YCB Agar Medium plates containing 5 mM acetamide (see Transformation of *K. lactis* GG799 Cells Step 11), harvest cells from an area approximately 1 mm² by scraping with a pipette tip and resuspending the cells in 100 μ l of 0.2 M LiAc containing 1% SDS (adapted from reference 10).
- Heat at 70°C for 15 minutes then add 300 μ l 100% ethanol and vortex to mix.
- Centrifuge the cells at 15,000 x g for 3 minutes at room temperature.
- Carefully remove the supernatant and air dry the pellet for 10 minutes.
- Resuspend the pellet in 50 μ l TE (10 mM Tris-HCl, pH 7.5 containing 1 mM EDTA).
- Centrifuge to remove any insoluble material for 30 seconds at 13,000 x g.
- Transfer the supernatant to a fresh tube and keep on ice. Use 1 μ l as a template for a 50 μ l PCR reaction as follows:

10X Integration Primer 2 (7.8 μ M stock)	3.2 μ l
10X Integration Primer 3 (7.8 μ M stock)	3.2 μ l
Q5 [®] High-Fidelity 2X Master Mix (NEB #M0492)	25 μ l
LiAc/SDS treated supernatant from Step 7 above	1.0 μ l
Deionized water	17.6 μ l
Final reaction volume	50 μ l

- Thermocycling should consist of an initial denaturation at 98°C for 30 seconds followed by 30 rounds (98°C for 10 seconds, 60°C for 30 seconds and 72°C for 75 seconds) and a final extension at 72°C for 2min.
- Analyze 10 μ l of each amplification reaction on a 1% agarose gel.
Cells harboring multiple tandem integrations of the expression fragment at the LAC4 locus in the K. lactis genome will result in amplification of a 2.58 kb product (Figure 8B).

10. Test strains harboring multiple copies of the expression fragment for secretion of the protein of interest (see Growth of strains for detection of secreted protein, page 10).

Optional Method III

Simultaneous Expression of Multiple Proteins

Selection of *K. lactis* cells transformed with pKLAC-series vectors by growth on YCB Agar Medium containing 5 mM acetamide nearly completely enriches transformant populations for cells that have inserted multiple tandem copies of the linear vector into the genome. Highly efficient multicopy integration can be exploited to rapidly create strains expressing multiple heterologous proteins using a single round of transformation and selection (5). This is accomplished by co-transforming *K. lactis* cells with two or more pKLAC-series vectors, each containing a different heterologous gene. Successful expression of up to four proteins has been reported using this method (5), although co-expression of more proteins may be possible. Read et al. have described this method in detail (5), however, an abbreviated protocol is provided here.

1. Separately digest 2 µg of each pKLAC2 vector containing a gene of interest with 20 units of SacII in 50 µl of 1X CutSmart Buffer (supplied as a 10X stock) at 37°C for 2 hours.
For example, to produce two proteins (protein A and protein B), the two constructs pKLAC2-gene-A and pKLAC2-gene-B would each be digested. The procedure can be performed with any combination of pKLAC-series vectors.
2. Pool the restriction digests and desalt the digested vectors using a commercially available DNA fragment purification kit [e.g., Monarch PCR & DNA Cleanup Kit (NEB #T1030)]. Elute in 30 µl deionized water.
*A total of 1 µg of each linearized vector in a volume less than 15 µl will be needed to transform *K. lactis* cells. DNA may be stored frozen at -20°C for up to one month prior to transforming *K. lactis* cells.*
3. Transform *K. lactis* GG799 cells with 15 µl of linearized vector DNA (containing 1 µg of each vector) using the method for “Transformation of *K. lactis* GG799 cells”, on page 9.
It is important to note that not all transformants will express both proteins. Acetamide selection nearly completely enriches transformant populations for multicopy integrants, however, it does not select for each vector individually. Therefore, it is important to screen multiple transformants for coexpression of proteins. In one study (5), 70–93% of strains transformed with two expression vectors produced both heterologous proteins, and 63% of cells transformed with three vectors produced all three proteins.

Figure 8. Integration of the expression cassette.

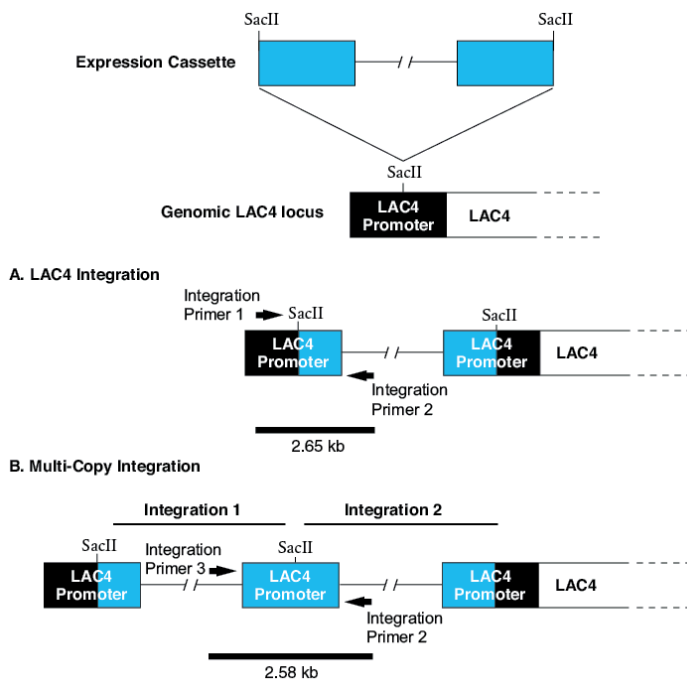

Upon transformation of *K. lactis* cells with the linearized expression cassette, the fragment inserts into the promoter of the *LAC4* locus. Single-copy integration at the *LAC4* locus can be detected by PCR using Integration Primers 1 and 2 to amplify a 2.65 kb diagnostic fragment (A), whereas multi-copy integration can be detected using Integration Primers 2 and 3 to amplify a 2.58 kb fragment (B).

Media & Solutions

40% Glucose or 40% Galactose Stock Solutions (1 liter)

Add 400 g glucose or galactose to 500 ml deionized water.

Dissolve by stirring, warm to 50°C to aid dissolution if needed.

Adjust volume to 1 liter with deionized water; dispense into 100 ml aliquots.

Filter sterilize or autoclave for 20 minutes at 121°C.

Solutions may degrade if autoclaved longer or at temperatures higher than recommended.

YPGlu & YPGal Media (1 liter)

Dissolve 10 g Yeast Extract and 20 g Bacto™ Peptone (Becton Dickinson #211820) in 950 ml deionized water.

Autoclave for 20 min at 121°C; let cool to room temperature.

Aseptically add 50 ml of sterile 40% glucose (for YPGlu) or 40% galactose (for YPGal).

Solid YPGlu and YPGal media can be made by adding 20 grams of Bacto™ agar (Becton Dickinson #214050) to the recipe prior to autoclaving.

1 M Tris-HCl Buffer Stock Solution pH 7.5 (1 liter)

Dissolve 121.14 g Tris (American Bioanalytical #AB14042) in 800 µl deionized water.

Adjust pH to 7.5 with the appropriate volume of concentrated HCl. Bring final volume to 1 liter with deionized water.

Autoclave. Store at room temperature.

1X PBS (phosphate-buffered saline) pH 7.4 (1 liter)

Dissolve the following in 800 ml deionized water:

8 g NaCl

0.2 g KCl

1.4 g Na₂HPO₄

0.24 g KH₂PO₄

Adjust the pH to 7.4.

Bring volume up to 1 L with deionized water.

Filter to sterilize.

Autoclaving may cause the solution to precipitate.

YCB Agar Medium with 5 mM acetamide (500 ml)

Mix in an autoclavable bottle:

15 ml 1 M Tris-HCl Buffer Stock Solution: pH 7.5

5.85 g YCB Medium powder (supplied with kit)

10 g Bacto agar (Becton Dickinson #214050)

Bring volume up to 495 ml with deionized water

Autoclave 20 minutes at 121°C. Let cool to ~60°C.

Aseptically add:

5 ml 100X Acetamide Stock Solution (supplied with kit)

Dispense into sterile disposable Petri dishes; close plates and let sit at room temperature until solid, then invert and let sit for 12–18 hours to dry prior to use.

*Yeast carbon base (YCB) medium contains glucose and all nutrients needed to sustain growth of *K. lactis* GG799 Competent Cells except a simple nitrogen source. Cells can utilize acetamide as a source of nitrogen only after it is broken down to ammonia by acetamidase (the product of the *amdS* gene present in *pKLAC2*). **Acetamide should not be autoclaved.***

References

1. Colussi, P. A. and Taron, C. H. (2005) *Appl. Environ. Microbiol.*, 71, 7092–7098.
2. van Ooyen, A. J. J. et al. (2006) *FEMS Yeast Research* 6, 381–392
3. Spohner, S. C. et. al. (2016) *J. Biotechnol.* 222:104–116.
4. Chuzel, L., Ganatra M. B. et. al. (2017) *Genome Announc* 5:e00623–17.
5. Read, J. D. et al. (2007) *Appl. Environ. Microbiol.*, 73, 5088–5096.
6. Platko, J. D. et al. (2008) *Protein Expr. Purif.* 57, 57–62.
7. Ekborg, N. A. et al. (2007) *Appl. Environ. Microbiol.*, 73, 7785–7788.
8. Foster, J. M. et. al. (2008) *Parasitol Res.* 104(5):1047
9. Vainauskas, S., Taron, C. H. (2016) New England Biolabs Application Note
10. Looke, M. et. al. (2011) *Biotechniques* 50:325–328.

Ordering Information

NEB #	PRODUCT	SIZE
E1000S	<i>K. lactis</i> Protein Expression Kit	
KIT COMPONENTS SOLD SEPARATELY		
R0157S/L	SacII	2,000/10,000 units
C1001S	<i>K. lactis</i> GG799 Competent Cells	5 reactions
B9017S	Yeast Carbon Base Medium Powder	12 grams

COMPANION PRODUCTS

NEB #	PRODUCT	SIZE
R0113S/L	BstXI	1,000/5,000 units
M0494S/L	Q5 [®] Hot Start High-Fidelity 2X Master Mix	400/2,000 units
C2987I/H	NEB 5-alpha Competent <i>E. coli</i> (High Efficiency)	6 x 0.2/ 20 x 0.05
C2989K	NEB 5-alpha Electrocompetent <i>E. coli</i>	6 x 0.1 ml
C2988J	NEB 5-alpha Competent <i>E. coli</i> (Subcloning Efficiency)	6 x 0.4 ml

Revision History

REVISION #	DESCRIPTION	DATE
1.1		7/11
2.0		9/18
3.0	New format applied	7/20
4.0	Change image seen for Cloning Strategy I and Cloning Strategy III	12/21

This product is intended for research purposes only. This product is not intended to be used for therapeutic or diagnostic purposes in humans or animals.

This product is covered by one or more patents, trademarks and/or copyrights owned or controlled by New England Biolabs, Inc. For more information about commercial rights, please email us at busev@neb.com. While NEB develops and validates its products for various applications, the use of this product may require the buyer to obtain additional third party intellectual property rights for certain applications.

Notice to Buyer/User: The *K. lactis* Protein Expression Kit was developed from basic research at New England Biolabs, Inc. and DSM Biologics Company B.V. The buyer and user has a non-exclusive sublicense to use this system or any component thereof, including the *K. lactis* GG799 Competent Cells, pKLAC1-malE, and the vector pKLAC2 for **RESEARCH PURPOSES ONLY**. A license to use this system for manufacture of clinical grade material or commercial purposes is available from New England Biolabs, Inc., or DSM Biologics Company B.V.

B CORPORATION[™] is a trademark of B Lab, Inc.

© Copyright 2021, New England Biolabs, Inc.; all rights reserved



be INSPIRED
drive DISCOVERY
stay GENUINE